





CAPANNOLI

since 1946

**Your
bathroom
accessories**

INDICE / INDEX

Design, evoluzione e visione: le novità Capannoli <i>Design, evolution and vision: what's new from Capannoli</i>	4
Collezione Arimo / Arimo collection  	6
Portabiancheria / Laundry basket	14
Specchi / Mirrors	22
Integrazioni / Additions	38
Finiture / Finishes	46

Design, evoluzione e visione: le novità Capannoli

Design, evolution and vision: What's new from Capannoli

Anche nel 2025 Capannoli conferma la propria vocazione all'innovazione, portando avanti un percorso progettuale fondato sull'equilibrio tra estetica, funzione e precisione tecnica. La nuova proposta non si limita a introdurre nuove collezioni, ma riflette una visione più ampia, attenta all'evoluzione degli spazi, dei comportamenti e delle abitudini del vivere contemporaneo.

Accanto alla collezione ARIMO, una linea essenziale dal profilo squadrato, nata per rispondere alla domanda di accessori rigorosi, funzionali e senza tempo, la brochure raccoglie una serie di interventi puntuali che vanno a completare, aggiornare e migliorare collezioni già presenti nel catalogo generale. In un'ottica di continuo affinamento del prodotto, Capannoli introduce elementi mirati come il portasalviette laterale Minima, i vassoi Teknika e il nuovo accessorio multifunzione Brick, pensati per aumentare le possibilità di utilizzo e rispondere con precisione a esigenze pratiche e progettuali.

I nuovi portabiancheria Oblò, Dina e Halo, esplorano materiali diversi e linguaggi formali distinti, offrendo soluzioni coerenti con le diverse configurazioni dello spazio domestico.

Mentre l'ampliamento della gamma specchi, con i nuovi modelli Back e Mira, affiancati da tre inediti specchi con cornici in alluminio, testimonia un approccio sempre più completo e sensibile ai diversi aspetti dell'abitare: contenitori nascosti, piccoli dettagli funzionali e possibilità di personalizzazione cromatica rendono lo specchio un elemento d'arredo a tutti gli effetti.

Infine, anche il sistema espositivo viene aggiornato, introducendo due nuovi pannelli che affiancano al rigore tecnico una dimensione visiva più libera e ispirata.

In ogni proposta si ritrova la coerenza del linguaggio Capannoli: una ricerca che non rincorre la novità come gesto formale, ma come risposta concreta ai bisogni reali di chi vive e progetta gli spazi oggi.

In 2025, Capannoli once again reaffirms its commitment to innovation, continuing a design journey grounded in the balance between aesthetics, functionality, and technical precision. The new offering goes beyond simply introducing new collections—it reflects a broader vision, one that is mindful of the evolving nature of spaces, behaviors, and the habits of contemporary living.

Alongside the ARIMO collection, a minimalist line with squared contours, designed to meet the demand for rigorous, functional, and timeless accessories, the brochure presents a series of carefully considered updates aimed at completing, refining, and enhancing collections already included in the main catalog. As part of its ongoing commitment to product development, Capannoli introduces targeted new elements such as the Minima side towel rail, Teknika trays, and the new Brick multifunctional accessory, all designed to increase versatility and precisely address practical and design needs.

The new laundry baskets Oblò, Dina, and Halo explore different materials and distinct formal languages, offering solutions in tune with the various configurations of the domestic space.

Meanwhile, the expansion of the mirror collection, with the new Back and Mira models accompanied by three original mirrors with aluminum frames, reflects an increasingly comprehensive approach, attentive to the many aspects of living: hidden storage, small functional details, and chromatic customization options turn the mirror into a true piece of furniture.

Lastly, the display system has also been updated, with the introduction of two new panels that combine technical precision with a freer, more inspired visual language.

Every proposal reflects the consistency of Capannoli's design language: a continuous pursuit that does not chase novelty for its own sake, but rather offers concrete responses to the real needs of those who live in and design today's spaces.



ARIMO

ARIMO è una collezione dal profilo squadrato, disegnata all'insegna dell'essenzialità. L'assenza della borchia e la geometria rigorosa dei volumi definiscono una presenza silenziosa ma precisa. Pensata per ambienti contemporanei, ARIMO unisce funzione e chiarezza formale con un'estetica discreta e senza tempo.

ARIMO is a collection with a square profile, designed with a focus on essentiality. The absence of rosettes and the geometric rigor of its volumes define a quiet yet precise presence. Conceived for contemporary spaces, ARIMO combines function and formal clarity with a discreet, timeless aesthetic.

La collezione Arimo è in ottone ed è disponibile nelle seguenti finiture

The Arimo collection is made of brass and is available in the following finishes



Laccati
Lacquered



Galvaniche
Galvanic



fissaggio con viti e tasselli
fixing with screws and wall-plugs

Impronta al muro / imprint on the wall: L.2,5 cm H.1,2 cm

per AR140F:
Impronta al muro / imprint on the wall: L.3,5 cm H.1,2 cm



ARIMO



AR130 L.30 cm - interasse / *ctc distance* **23,2 cm**

AR140 L.40 cm - interasse / *ctc distance* **33,2 cm**

AR155 L.55 cm - interasse / *ctc distance* **48,3 cm**



AR107



AR109



AR114 da terra / *floor standing*
AR115 a parete / *to the wall*

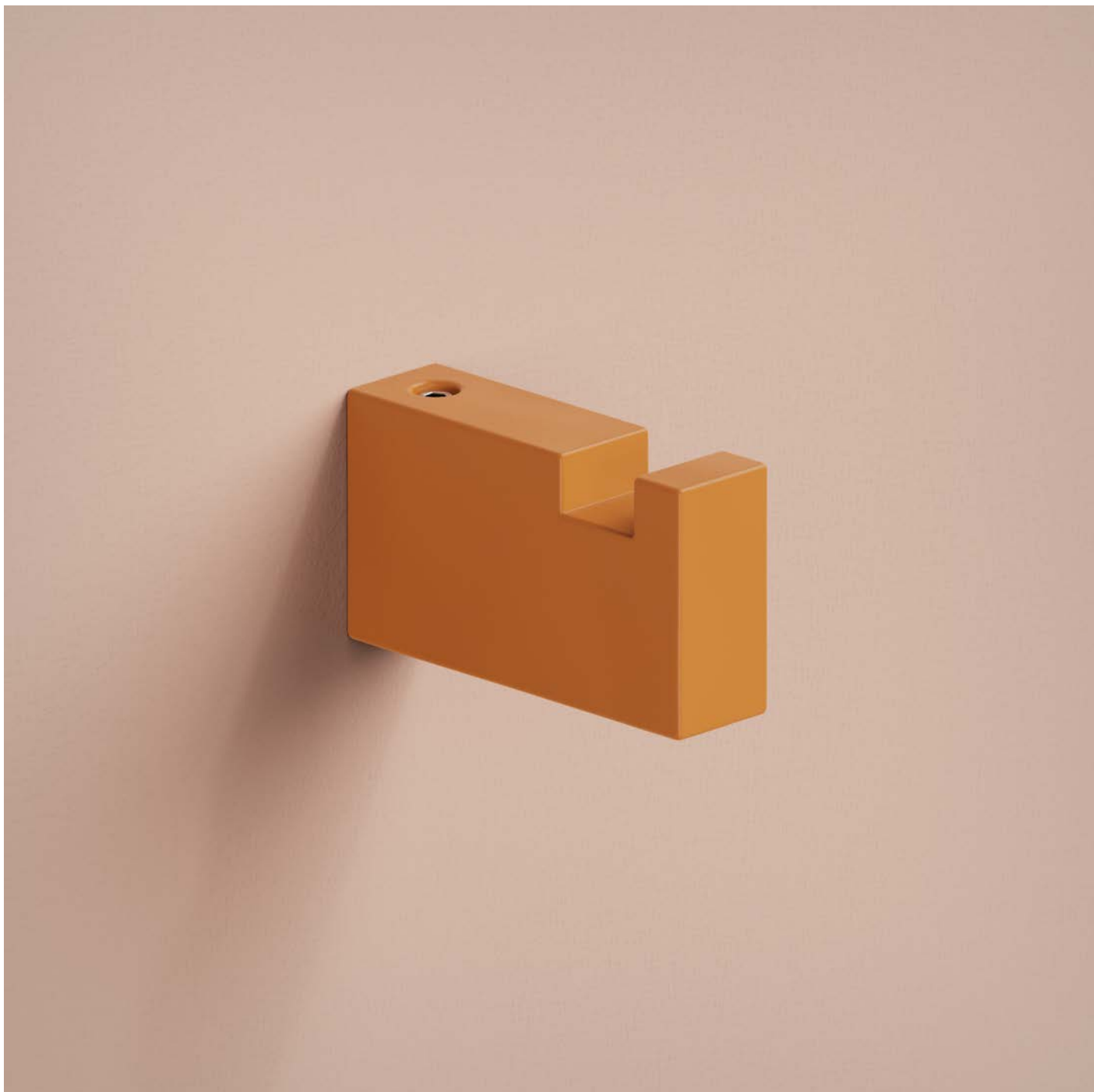

AR109
RAL 2000 - Arancione opaco / *Matt orange*

ARIMO



AR140F L.39 cm
Porta salviette da mobile / *Cabinet-mounted towel holder*



AR110 L.23 cm
Porta salviette bidet / *Bidet towel holder*



AR111/1 L.35 cm
Porta salviette a bandiera / *Perpendicular towel-holder*



ARIMO



AR119 da appoggio / *standing*



AR113 da appoggio / *standing*



AR116 a parete / *to the wall*



AR103 a parete / *to the wall*



AR176
base / base 10x10 cm
L.10 cm H.62,5 cm P.16 cm

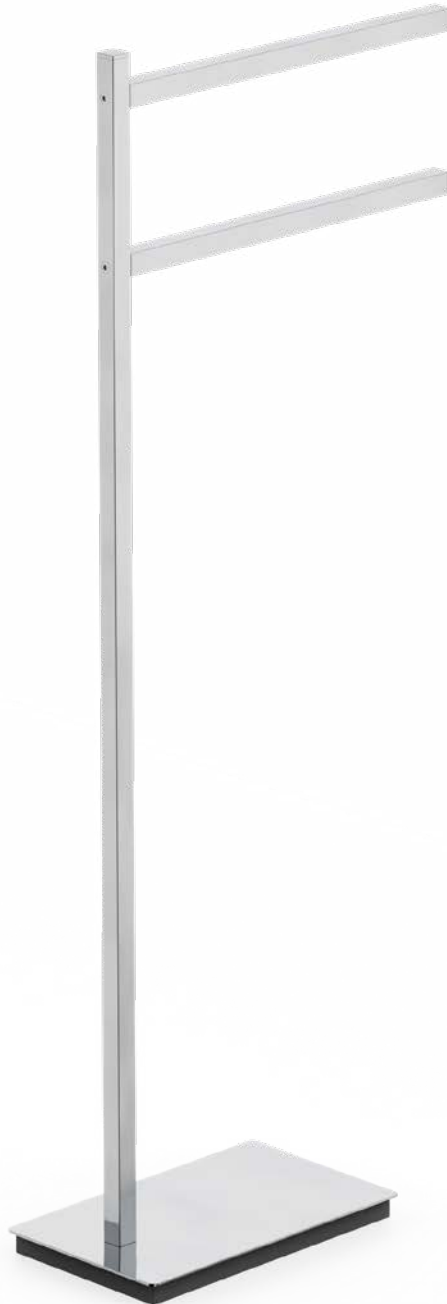

AR171
base / base P. 23 cm L.14 cm
L.14 cm H.82 cm P.34 cm

PORTABIANCHERIA

LAUNDRY BASKET

I portabiancheria reinterpretano un oggetto quotidiano con materiali resistenti, geometrie funzionali e soluzioni pensate per gli spazi del bagno moderno. Leggere o strutturate, sempre facili da usare, offrono funzionalità, durabilità ed equilibrio estetico. Le diverse finiture permettono un'integrazione armoniosa e coordinata in ogni ambiente.

Laundry baskets reinterpret a daily-use object through durable materials, functional geometries, and solutions designed for modern bathroom spaces. Whether lightweight or structured, they are always easy to use, offering practicality, long-lasting quality, and visual balance. The range of finishes allows for harmonious and coordinated integration in any setting.



OBLÒ

Oblò è una cesta leggera e funzionale, composta da un sacco in fibra di cellulosa, resistente, lavabile e disponibile in due colori. La chiusura avviene tramite un disco colorato e magnetico che aggiunge un dettaglio pratico e distintivo. Oblò è in fibra di cellulosa e ottone.

Oblò is a lightweight and functional basket, made of a cellulose fiber sack that is durable, washable, and available in two colors. It features a magnetic, colored disc closure that adds a practical and distinctive detail. Oblò is made of cellulose fiber and brass.

Tessuto

Fabric



Beige
Beige



Grigio
Grey

Disco magnetico

Magnetic disc closure



Laccati
Lacquered



Galvaniche
Galvanic



OB190

L.45 cm H.65 cm P.30cm
Capacità / Capacity 74 L



OB191

L.35 cm H.65 cm P.25cm
Capacità / Capacity 48 L



OB190
Beige / Beige + RAL 5024 - Celeste opaco / Matt light blue

DINA

Dina combina una struttura in tondini colorati con un resistente sacco in cotone riciclato agganciato alla struttura in metallo. Il coperchio in legno con foro ne facilita l'apertura e l'uso quotidiano. È disponibile anche in una versione angolare, pensata per sfruttare al meglio gli spazi. Dina ha la struttura in acciaio, il sacco in tessuto lavabile disponibile in due colori differenti e il coperchio in multistrato di rovere colore chiaro.

Dina combines a structure of colored metal rods with a durable recycled cotton bag attached to the frame. The wooden lid with an opening hole makes it easy to lift and practical for everyday use. It is also available in a corner version, designed to optimize space.

Dina features a steel frame, a washable fabric bag available in two different colors, and a light oak plywood lid.

Tessuto

Fabric



Beige
Beige



Grigio
Grey

Struttura

Frame



Laccati
Lacquered

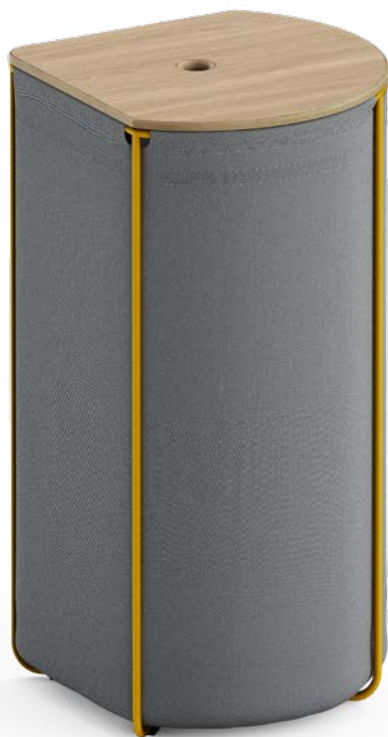

DN190T

L.35,8 cm H.70,9 cm P.35,8 cm
Capacità / *Capacity* 65 L



DN190R

L.41 cm H.57,9 cm P.31 cm
Capacità / *Capacity* 67 L



Coperchio in rovere chiaro
Light oak lid



DN190T
Beige / Beige + RAL 1032 - Giallo opaco / Matt yellow

HALO

Con la sua linea pulita e geometrica e il coperchio in legno dotato di foro centrale per l'apertura, Halo interpreta il tema della raccolta biancheria con essenzialità e cura per i dettagli. Il sacco interno in poliestere, estraibile e lavabile, rende l'utilizzo quotidiano pratico e immediato.

Halo è in lamiera di acciaio verniciata con coperchio in multistrato di rovere e sacco in poliestere.

With its clean, geometric lines and a wooden lid featuring a central opening hole, Halo interprets the laundry basket with essentiality and attention to detail. The inner bag, made of polyester, removable and washable, makes everyday use practical and straightforward. Halo is made of painted steel sheet with an oak plywood lid and a polyester sack.

Struttura

Body



Laccati
Lacquered



Il portabiancheria Halo è provvisto di sacca estraibile con pratici manici, realizzata in poliestere resistente e facilmente lavabile.
The Halo laundry basket is equipped with a removable sack with practical handles, made of durable and easy-to-clean polyester.



Coperchio in rovere chiaro
Light oak lid

HL190
Ø36 cm
H.60 cm
Capacità / Capacity 53 L



HL190
RAL 6021 - Verde salvia opaco / *Matt sage green*

SPECCHI *MIRRORS*

Funzionali, versatili e progettati per integrarsi, i nuovi specchi ampliano il programma Capannoli con soluzioni pensate per completare e personalizzare l'ambiente bagno e non solo. Alcuni modelli celano vani contenitivi e offrono funzionalità inaspettate, pensate per rispondere ai bisogni reali dell'abitare contemporaneo. La collezione si arricchisce di tre specchi con cornice in alluminio, che ampliano le possibilità di interpretazione e di integrazione formale. Ogni proposta si adatta con equilibrio alle esigenze progettuali e d'uso quotidiano, unendo precisione tecnica, varietà di finiture e cura per il dettaglio.

Functional, versatile and designed to integrate seamlessly, the new mirrors expand the Capannoli program with solutions conceived to complete and personalize the bathroom environment and beyond. Some models conceal storage compartments and offer unexpected functions, responding to the real needs of contemporary living. The collection is enriched with three mirrors featuring aluminum frames, broadening the possibilities of interpretation and formal integration. Each proposal adapts harmoniously to design requirements and everyday use, combining technical precision, a variety of finishes and attention to detail.



BACK

Back è una collezione di specchi contenitori che coniuga funzione e discrezione. L'anta a specchio si apre su un vano nascosto con mensole e si richiude dolcemente grazie alle cerniere Blum con sistema ammortizzato Blumotion. Accanto, uno spazio a giorno sempre accessibile completa lo specchio, offrendo due aree contenitive distinte che ne aumentano capacità e versatilità.

Back è realizzato in lamiera d'acciaio.

Back is a collection of mirrored cabinets that combines function with discretion. The mirrored door opens to reveal a hidden compartment with shelves and closes softly thanks to Blum hinges with the Blumotion soft-close system. Alongside, an open compartment—practical and always accessible—completes the mirror, offering two distinct storage areas that increase both capacity and versatility.

Back is made of sheet steel.



Laccati
Lacquered



Tutti gli specchi Back sono reversibili in fase di installazione.

All Back mirrors are reversible during installation.

BM606 L.60 cm H.60 cm P.9 cm
BM808 L.80 cm H.80 cm P.9 cm
BM108 L.100 cm H.80 cm P.9 cm

BM4515
L.45 cm H.150 cm P.9 cm

L'anta a specchio è dotata di **cerniere Blum** con sistema ammortizzato Blumotion per una chiusura fluida e silenziosa.

*The mirrored door is fitted with **Blum hinges** with the Blumotion soft-close system, ensuring a smooth and silent closure.*



BM606
RAL 1032 - Giallo opaco / *Matt yellow*

BM4515
RAL 1032 - Giallo opaco / *Matt yellow*

BACK

Tutti gli specchi Back sono reversibili in fase di installazione.

All Back mirrors are reversible during installation.

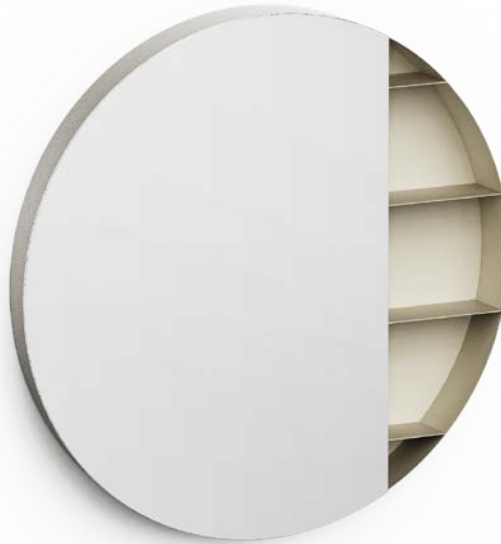

BM850
L.55 cm H.85 cm P.9 cm

BM60D Ø 60 cm
BM80D Ø 80 cm

L'anta a specchio è dotata di **cerniere Blum** con sistema ammortizzato Blumotion per una chiusura fluida e silenziosa.

*The mirrored door is fitted with **Blum hinges** with the Blumotion soft-close system, ensuring a smooth and silent closure.*



BM80D
RAL 1015 - Beige opaco / *Matt beige*

BACK

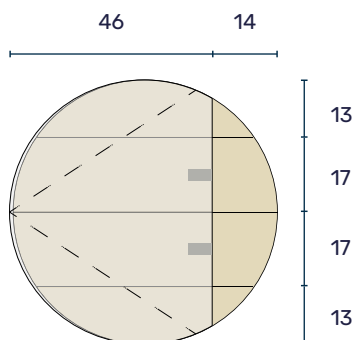

BM60D
Ø 60 cm P.9 cm

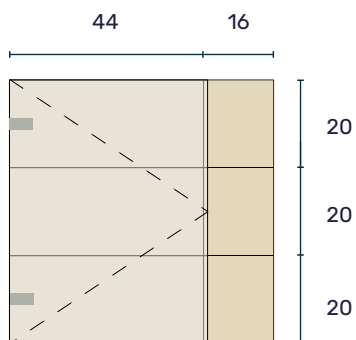

BM606
L.60 cm H.60 cm P.9 cm

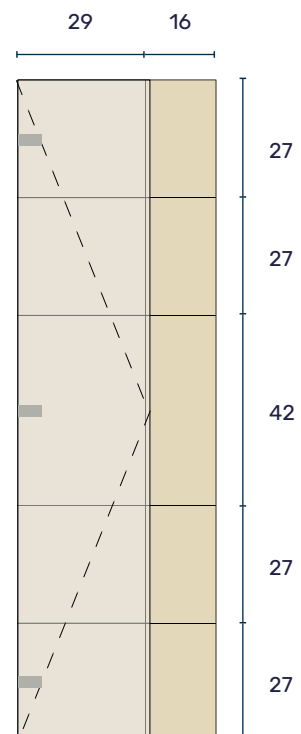

BM4515
L.45cm H.150 cm P.9 cm

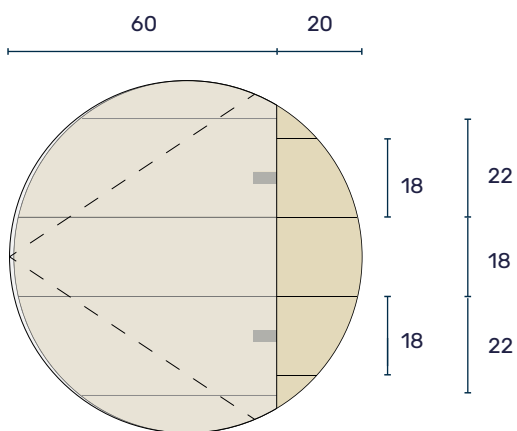

BM80D
Ø 80 cm P.9 cm

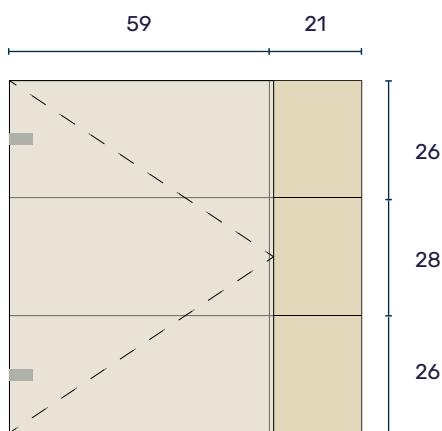

BM808
L.80 cm H.80 cm P.9 cm

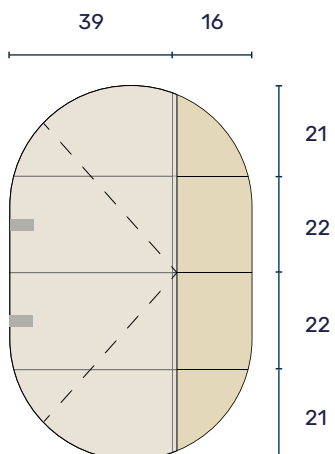

BM850
L.55 cm H.85 cm P.9 cm

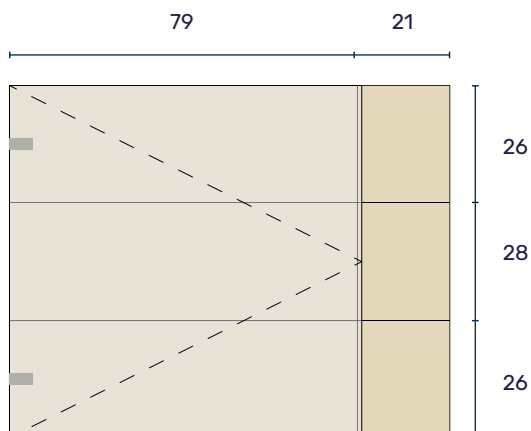

BM108
L.100 cm H.80 cm P.9 cm

Tutti gli specchi Back sono reversibili
in fase di installazione.
All Back mirrors are reversible during installation.

■ Cerniera Blum / Blum hinge

L'anta a specchio è dotata di **cerniere Blum** con sistema ammortizzato Blumotion per una chiusura fluida e silenziosa.

*The mirrored door is fitted with **Blum hinges** with the Blumotion soft-close system, ensuring a smooth and silent closure.*



BM80D
RAL 1015 - Beige opaco / *Matt beige*

MIRA

Mira è uno specchio in acciaio essenziale con un dettaglio funzionale inatteso. La cornice inferiore si estende per diventare una mensola: uno spazio comodo per appoggiare piccoli oggetti d'uso quotidiano. Le finiture disponibili permettono di integrare Mira con coerenza e carattere in ogni ambiente. Mira è in acciaio.

Mira is a minimal mirror with an unexpected functional detail. The lower frame extends to form a shelf – a convenient space for everyday items. Available in a range of finishes, Mira integrates seamlessly and with character into any setting.

Mira is made of steel.



Laccati

Lacquered



MR60D Ø60



MR80D Ø80



MR60DL Ø60

LUCE LED 4000K – su richiesta 3000K
LED light 4000K – 3000K available upon request

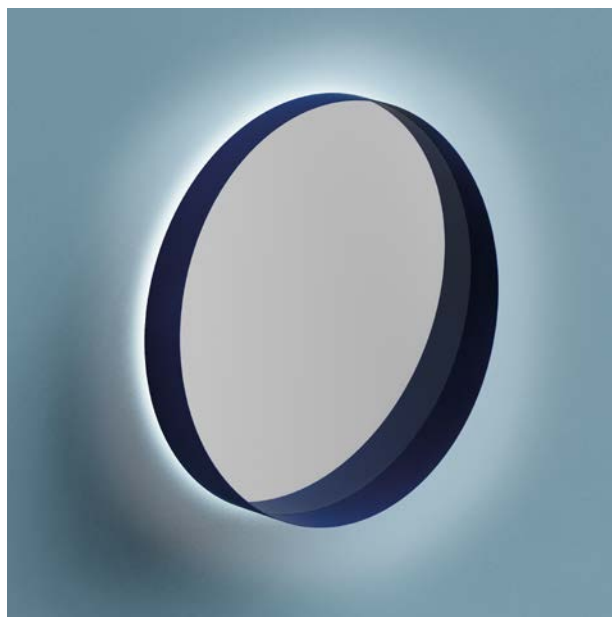

MR80DL Ø80

LUCE LED 4000K – su richiesta 3000K
LED light 4000K – 3000K available upon request

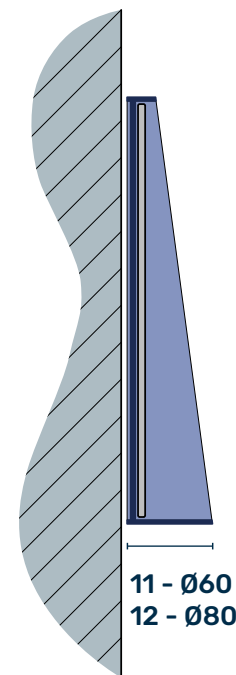



MR60DL
RAL 5011 - Blu opaco / *Matt blue*

DUAL

Dual reinterpreta la tradizione delle cornici profonde in chiave contemporanea. La struttura in alluminio conferisce solidità e rigore, richiamando la memoria delle cornici in legno, con la possibilità di scegliere anche la variante ad angoli arrotondati.

Dual reinterprets the tradition of deep frames in a contemporary way. The aluminum structure conveys solidity and precision, evoking the memory of wooden frames, with the option of a version featuring rounded corners.



Laccati
Lacquered

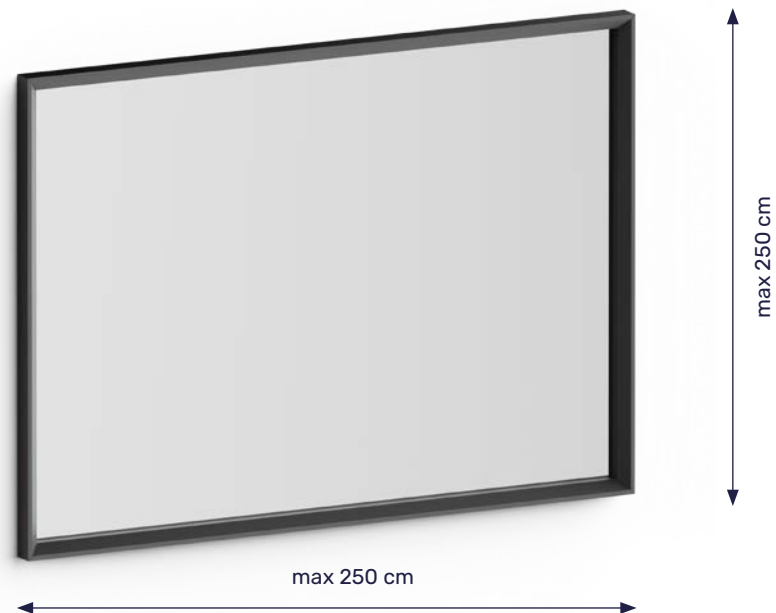
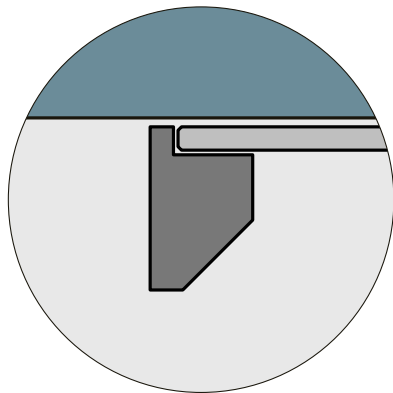

Dimensioni personalizzabili
Made-to-measure dimensions

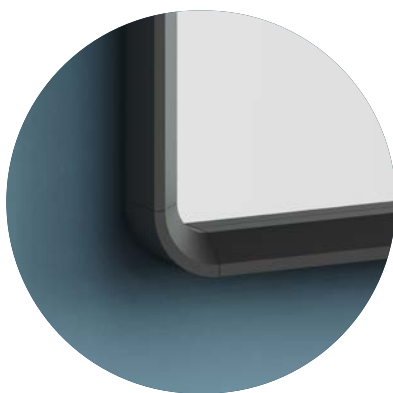

Versione angolo arrotondato
Rounded corner version

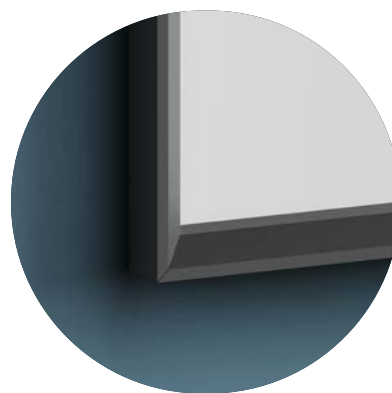

Versione angolo squadrato
Squared corner version

Per le opzioni di configurazione del tipo di luce, fare riferimento alle pagine 212-213 del catalogo generale.
For light configuration options, please refer to pages 212-213 of the general catalogue.



DUAL + LEDPERM
RAL 3013 - Rosso opaco / *Matt red*

DUAL LED

Dual Led aggiunge alla cornice in alluminio una sorgente luminosa integrata che trasforma lo specchio in elemento tecnico e funzionale. La luce diffusa valorizza la superficie riflettente e rende l'utilizzo quotidiano più confortevole, disponibile anch'esso nella versione con angoli arrotondati.
Dual Led enhances the aluminum frame with an integrated light source, turning the mirror into both a functional and technical element. The diffused light highlights the reflective surface and makes daily use more comfortable, also available with rounded corners.

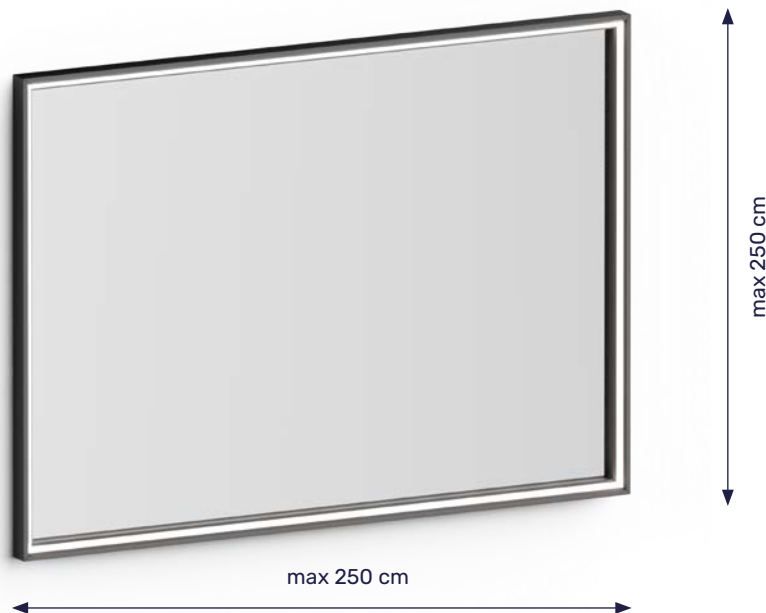
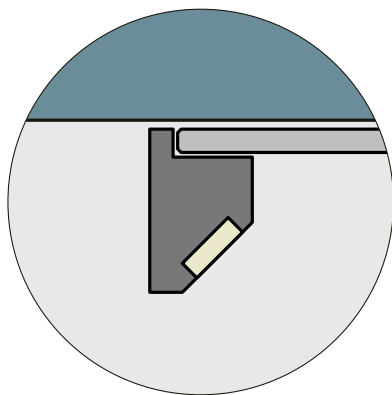

Dimensioni personalizzabili
Made-to-measure dimensions



Versione angolo arrotondato
Rounded corner version

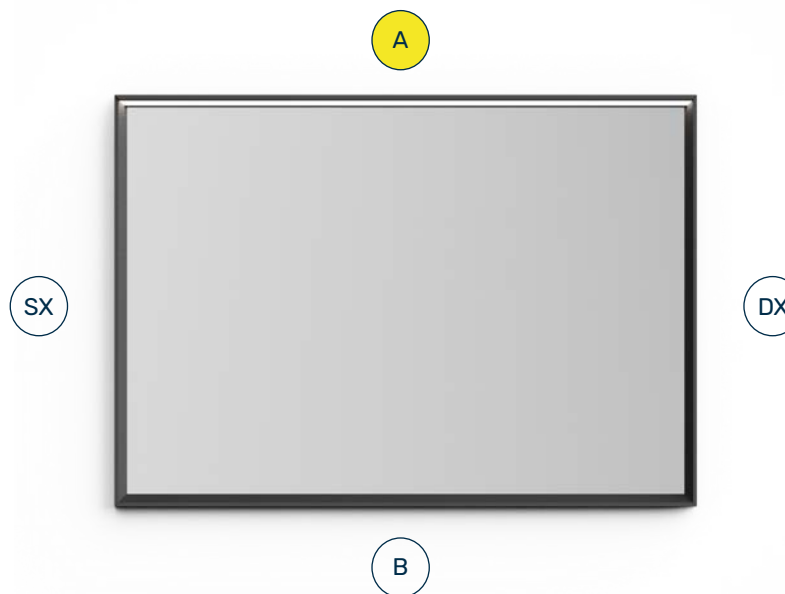

In fase di ordine scegliere il lato o i lati su cui avere i LED.
When ordering, choose the side or sides on which to have the LEDs.

Per altre opzioni di configurazione del tipo di luce, fare riferimento alle pagine 212-213 del catalogo generale.
For light configuration options, please refer to pages 212-213 of the general catalogue.

DUAL LED



DUAL LED - SX + DX - angoli arrotondati / rounded corners
RAL 7024 - Grigio scuro opaco / *Matt dark grey*

VERSO

Verso propone una cornice in alluminio sottile e raffinata che esalta la purezza dello specchio senza sovraccaricarne il disegno. Una soluzione elegante e leggera, disponibile anche nella variante con angoli arrotondati.

Verso features a thin and refined aluminum frame that emphasizes the purity of the mirror without overloading its design. An elegant and lightweight solution, also offered in a rounded-corner version.



Laccati
Lacquered

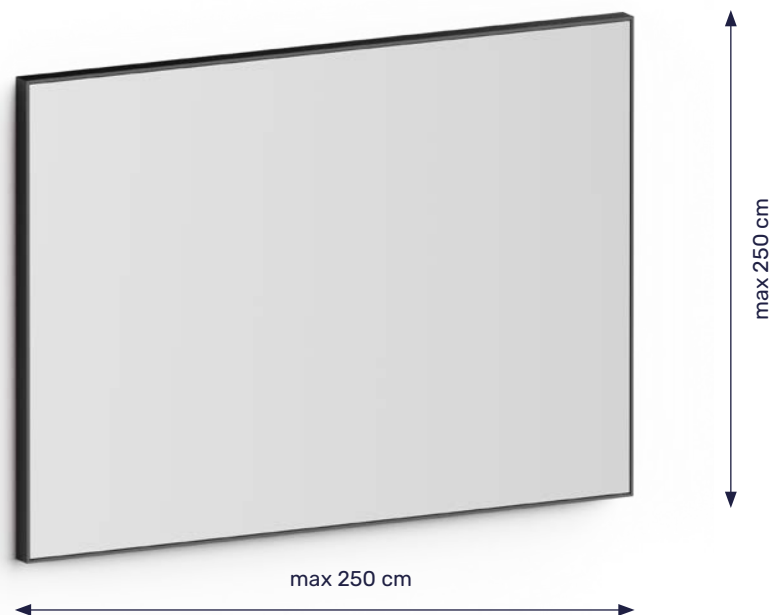
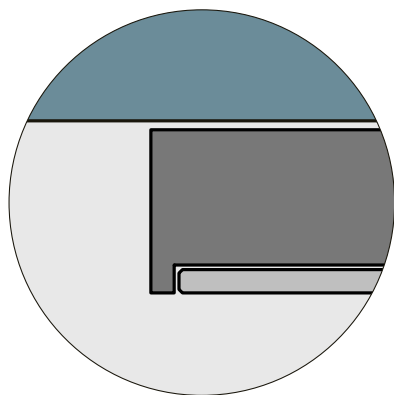

Dimensioni personalizzabili
Made-to-measure dimensions



Versione angolo arrotondato
Rounded corner version

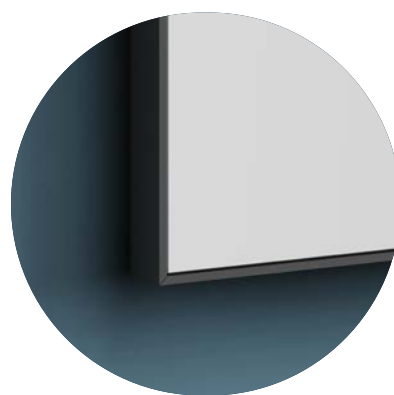

Versione angolo squadrato
Squared corner version

Per le opzioni di configurazione del tipo di luce, fare riferimento alle pagine 212-213 del catalogo generale.
For light configuration options, please refer to pages 212-213 of the general catalogue.



VERSO
RAL 9010 - Bianco opaco / *Matt white*

INTEGRAZIONI *ADDITIONS*

Gli elementi presentati in questa sezione nascono per integrare e completare collezioni già esistenti. Soluzioni mirate, sviluppate in un'ottica di continuo miglioramento e sulla base delle indicazioni raccolte da progettisti, rivenditori e clienti. Capannoli osserva i cambiamenti del vivere quotidiano e rinnova costantemente la propria offerta, intervenendo con attenzione anche sulle linee già consolidate, per migliorarle, arricchirle e renderle sempre attuali.

The items presented in this section are designed to integrate and complete existing collections. Targeted solutions developed with a view to continuous improvement and based on feedback from designers, retailers, and end users. Capannoli closely observes changes in everyday life and constantly updates its offering, carefully enhancing even its most established lines to keep them relevant, functional, and in tune with the times.



MINIMA

La collezione Minima si arricchisce di un portasalviette pensato per essere installato direttamente sul fianco del mobile bagno. Una soluzione compatta e funzionale, pensata per rispondere alle abitudini del vivere contemporaneo senza rinunciare all'essenzialità che caratterizza la linea.

The Minima collection is enhanced with a towel rail designed to be installed directly on the side of the bathroom cabinet.

A compact and functional solution, created to meet the needs of contemporary living without compromising the essential character of the line.



Laccati
Lacquered



Galvaniche
Galvanic



MM140/F

L.40,8 cm H.1,4 cm P.6,3 cm

Interasse / ctc distance 3,4 cm

BRICK

La collezione Brick si arricchisce di un nuovo accessorio che integra mensola, portarotolo e portasalviette in un'unica soluzione compatta e funzionale. Un accessorio multifunzionale pensato per ottimizzare lo spazio. Brick è in acciaio AISI 304.

The Brick collection is enhanced with a new accessory that combines a shelf, toilet paper holder, and towel rail in a single compact and functional solution. A multifunctional piece designed to optimize space. Brick is made of AISI 304 stainless steel.



Laccati
Lacquered



BK140/7 D

L.53 H.10,8 cm P.10,4 cm



BK140/7 S

L.53 H.10,8 cm P.10,4 cm



BK140/7 S
RAL 1032 - Giallo opaco / *Matt yellow*

TEKNIKA

La collezione Teknika si arricchisce di due vassoi di diverse dimensioni, concepiti per accogliere e organizzare gli elementi della serie oppure per contenere piccoli oggetti d'uso quotidiano. Essenziali e versatili, completano la linea riprendendone la pulizia formale e le finiture opache. I vassoi Teknika sono in resina bianco opaco o nero opaco.

The Teknika collection expands with two trays in different sizes, designed to accommodate and organize the elements of the series or to hold small every-day objects. Essential and versatile, they complete the line by echoing its formal clarity and matte finishes.

Teknika trays are available in matte white or matte black resin.

BI

Resina bianca opaca
Matt white resin

NE

Resina nera opaca
Matt black resin

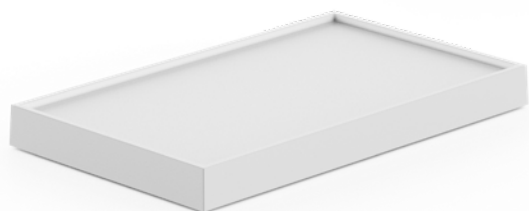

TK17RBI



TK17RNE



TK17EBI



TK17ENE



Collezione Teknika in resina bianca
Teknika collection in white resin

ESPOSITORI MODULARI I & J

MODULAR DISPLAYS I AND J

Due nuovi pannelli si aggiungono al sistema di espositori modulari Capannoli.

Il pannello I (L.25 H.80) raccoglie tutte le finiture disponibili in un formato compatto e ordinato, ideale per avere a colpo d'occhio la varietà materica dell'offerta. Il pannello J (L.50 H.80) propone un'esperienza visiva più libera e suggestiva: su fondo blu profondo, tutte le finiture Capannoli brillano come frammenti di luce in un cielo notturno, mettendo in scena la varietà e il carattere delle finiture.

Two new panels join the Capannoli modular display system.

Panel I (W.25 H.80) brings together all available finishes in a compact, well-organized format – ideal for a quick overview of the material variety on offer.

Panel J (W.50 H.80) offers a freer and more evocative visual experience: set against a deep blue background, all Capannoli finishes shine like fragments of light in a night sky, showcasing the variety and character of the materials.



I - L.25 cm H.80 cm
 Appendini in tutte le 32 finiture
 Coat hanger in all 32 finishes

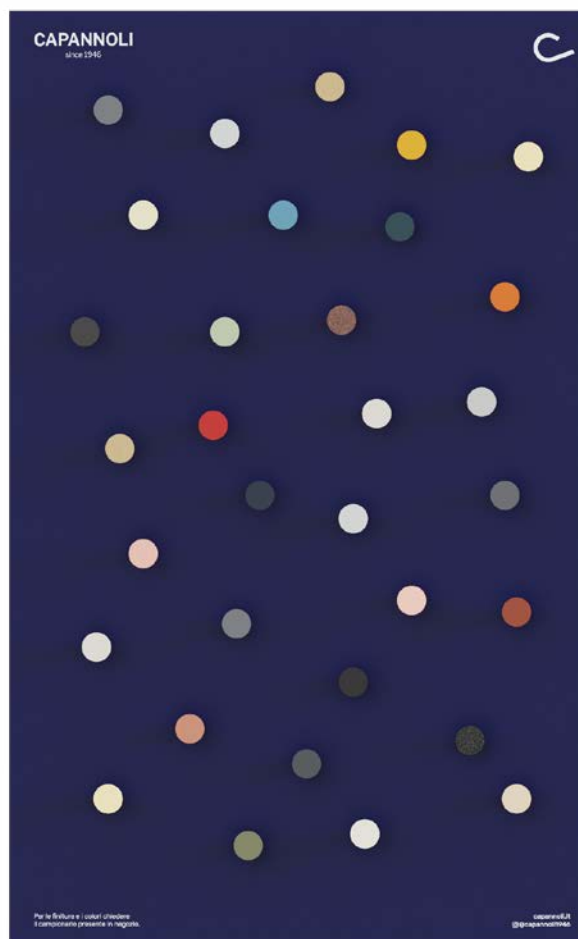

J - L.50 cm H.80 cm
 Appendini in tutte le 32 finiture
 Coat hanger in all 32 finishes



Realizzati con / Made with PR109/1
 Appendino applicabile anche a parete
 Also suitable for wall mounting

ESEMPI DI COMPOSIZIONI CON ESPOSITORI MODULARI I & J

EXAMPLES OF COMPOSITIONS WITH MODULAR DISPLAYS I AND J



G+I+B+D+D
L.150 cm H.80 cm

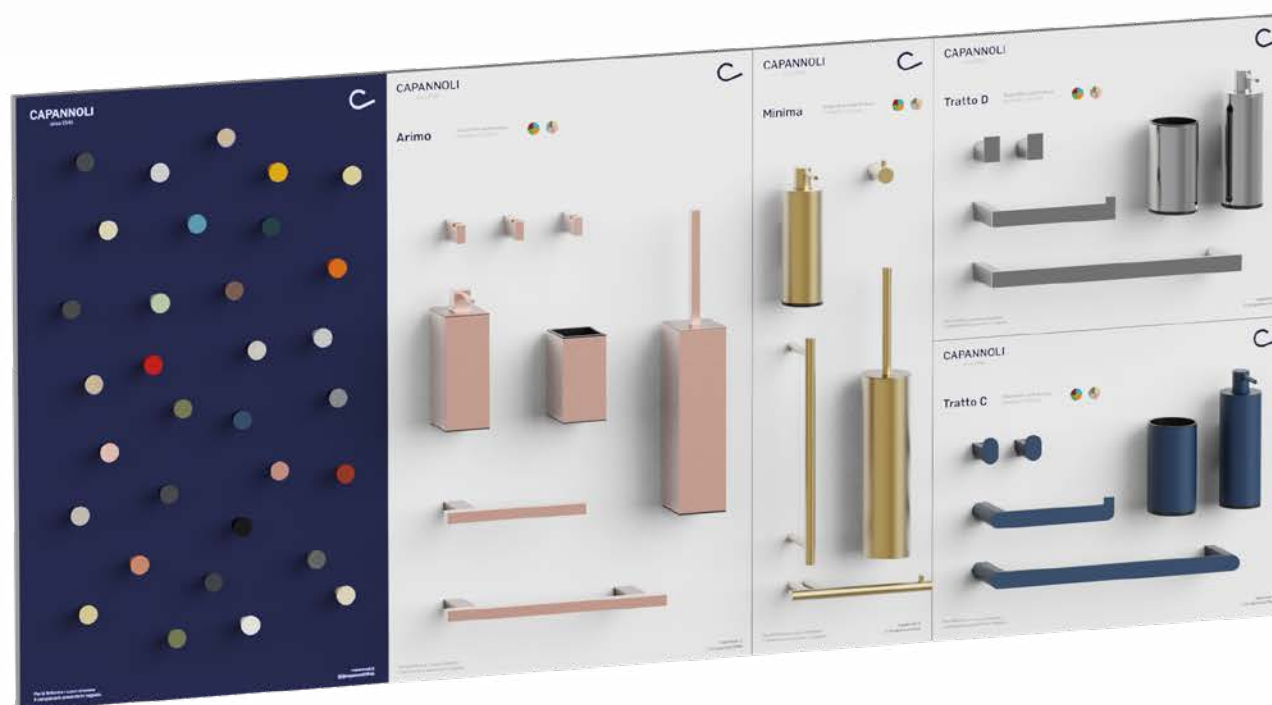

J+B+C+D+D
L.175 cm H.80 cm

FINITURE / FINISHES

Acciaio

Steel



Polimeri

Polymers



Tessuto

Fabric



Legno

Wood



solo per le collezioni AKO e LEKA
only for the AKO and LEKA collections

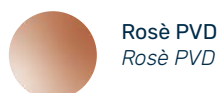
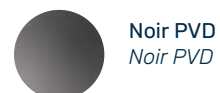



Finiture Laccate

Lacquered Finishes



RAL9010
Bianco opaco
Matt white



RAL7044
Grigio chiaro opaco
Matt light grey



RAL7024
Grigio scuro opaco
Matt dark grey



1
Grigio antracite
Anthracite grey



RAL9005
Nero opaco
Matt black



D
Ruggine
Rust



RAL2013
Mattone opaco
Matt brick



RAL3013
Rosso opaco
Matt red



RAL2000
Arancione opaco
Matt orange



RAL1032
Giallo opaco
Matt yellow



RAL3012
Rosa opaco
Matt pink



RAL1015
Beige opaco
Matt beige



RAL6021
Verde salvia opaco
Matt sage green



RAL6003
Verde oliva opaco
Matt olive green



RAL5020
Blu oceano opaco
Matt ocean blue



RAL5011
Blu opaco
Matt blue



RAL5024
Celeste opaco
Matt light blue



Finiture Galvaniche

Galvanic Finishes



3
Cromo
Chrome



H
Nichel matt
Matt nickel



V
Nichel satinato
Satin nickel



2
Canna fucile lucido
Glossy metalgun



À
Canna fucile
satinato lucido
Satin glossy metalgun



É
Canna fucile
satinato opaco
Satin matt metalgun



9
Bronzo scuro
Dark bronze



Z
Bronzo satinato
Satin bronze



R
Oro
Gold



T
Oro satinato opaco
Satin matt gold



Y
Ottone satinato
Satin brass



8
Bronzo satinato opaco
Satin matt bronze



O
Oro rosa opaco
Rose matt gold



F
Oro rosa
Rose gold



W
Rame satinato
Satin copper



Scarica qui il catalogo!
Download the catalog here!

Il presente catalogo è di proprietà di
Capannoli s.r.l. unipersonale.
Capannoli s.r.l. si riserva di apportare modifiche
tecniche ed estetiche ove ritenga necessario.
I colori dei prodotti possono risultare talvolta
diversi da quelli riprodotti in questo catalogo.
Tutti i diritti riservati.
Sono vietate riproduzione e alterazione.

This catalogue is property of
Capannoli s.r.l. unipersonale.
Capannoli S.r.l. reserves the right to make technical
and aesthetic changes where deemed necessary.
The colors of the products may sometimes differ from
those shown in this catalog.
All rights reserved.
Reproduction and alterations are forbidden.

Creative direction: **BSDS**
Progetto grafico / *Graphic project:* **Studio Moby**
3D styling: **BSDS, Gloria Citterio**
3D Render & Postproduction:
BSDS, Gloria Citterio, Riccardo Tonin

Finito di stampare presso la tipografia
Finished printing at the typography
CIANI ARTIGRAFICHE S.R.L.
09/2025